

# Magiccos

## TYPE FP408

---

### Instruction Manual & Recipes



Magiccos Stainless Steel Food Processor With Built-in Drawer

Version 2.2

# CONTENTS

Product Introduction & Parts .....	1
Packing Contents .....	2
Important Safety Cautions .....	3
Technical Specification .....	6
Product Features .....	7
Safety Lock System .....	7
Overheating Protection .....	7
Small, Medium & Big Feed Chute & Food Residues .....	8
Blade Storage Drawer .....	10
Led Indicators & Working Condition .....	11
How To Select Speeds .....	12
How to Use the Appliance .....	13
Installation .....	13
How to use chopper blade .....	15
How to use dough blade .....	17
How to use 5 insert cutting blades .....	19
Maintenance .....	23
Cleaning .....	24
Warranty .....	27
Basic Warranty Information .....	27
Terms & Policy .....	27
Defective Products & Returns .....	28
Warranty and Accessories .....	29
Delivery for Replacement .....	30
Troubleshooting .....	31
Appliance doesn't work .....	31
Appliance stops running suddenly .....	32
Motor is running while components DO NOT run .....	32
Difficult to install the chopper blade and drive shaft .....	33
Appliance shakes violently .....	34
Chopping performance is not good enough .....	35
Slicing /grating performance is not good enough .....	35
Unpleasant smell .....	36
Liquid leakage problem .....	36
Rusting of metal parts .....	37
Missing parts or broken parts .....	37
Recipes .....	38
Contact Us .....	49



# Product Introduction & Parts

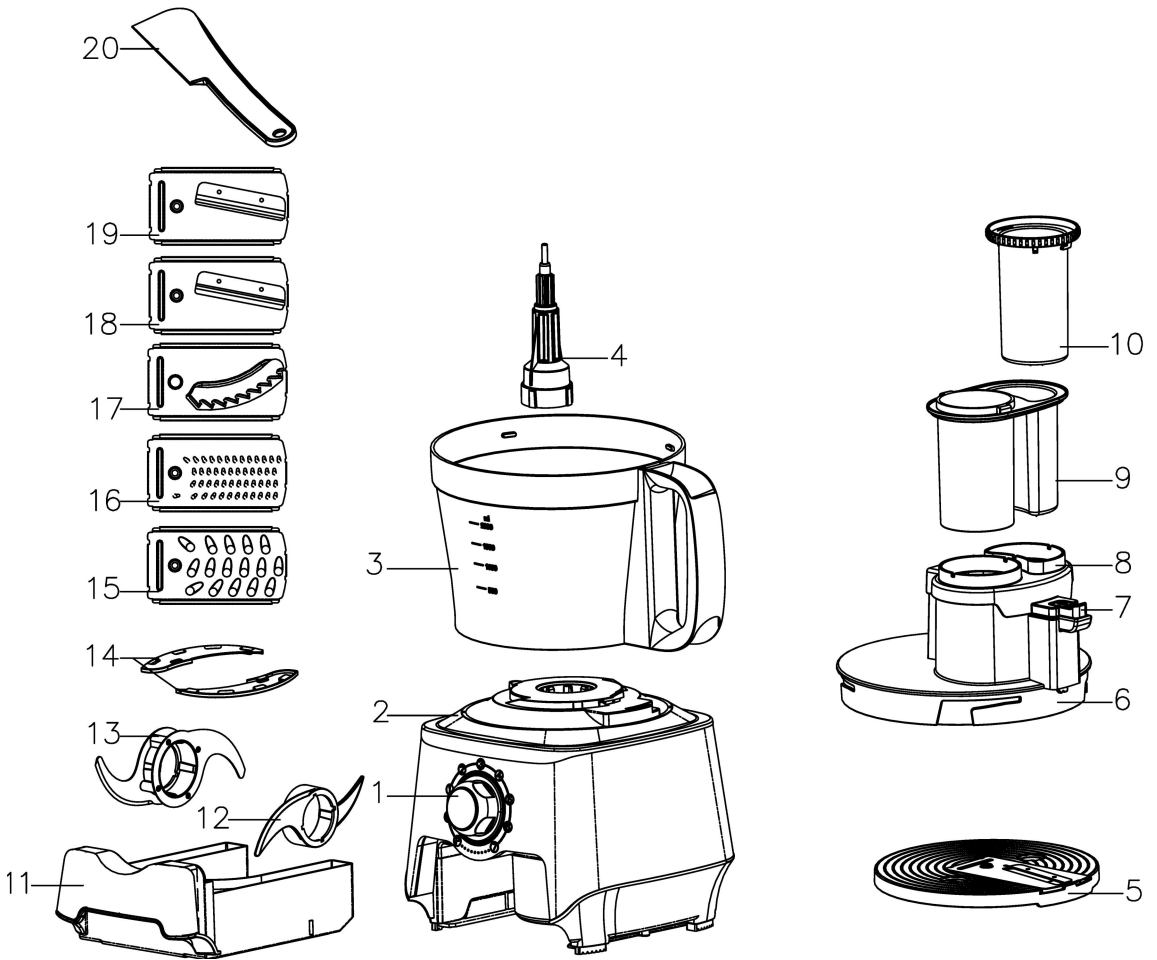

① Rotary switch	② Motor base	③ Food processor bowl
④ Drive shaft	⑤ Blade holder disc	⑥ Bowl lid
⑦ Safety lock buckle	⑧ Protective cover	⑨ Big pusher
⑩ Small pusher	⑪ Blade drawer	⑫ Dough blade
⑬ Chopper blade	⑭ Blade protectors	⑮ Coarse shredding insert blade
⑯ Fine shredding insert blade	⑰ French fry insert blade	⑱ Coarse slicing insert blade
⑲ Fine slicing insert blade	⑳ Spatula	

## Packing Contents

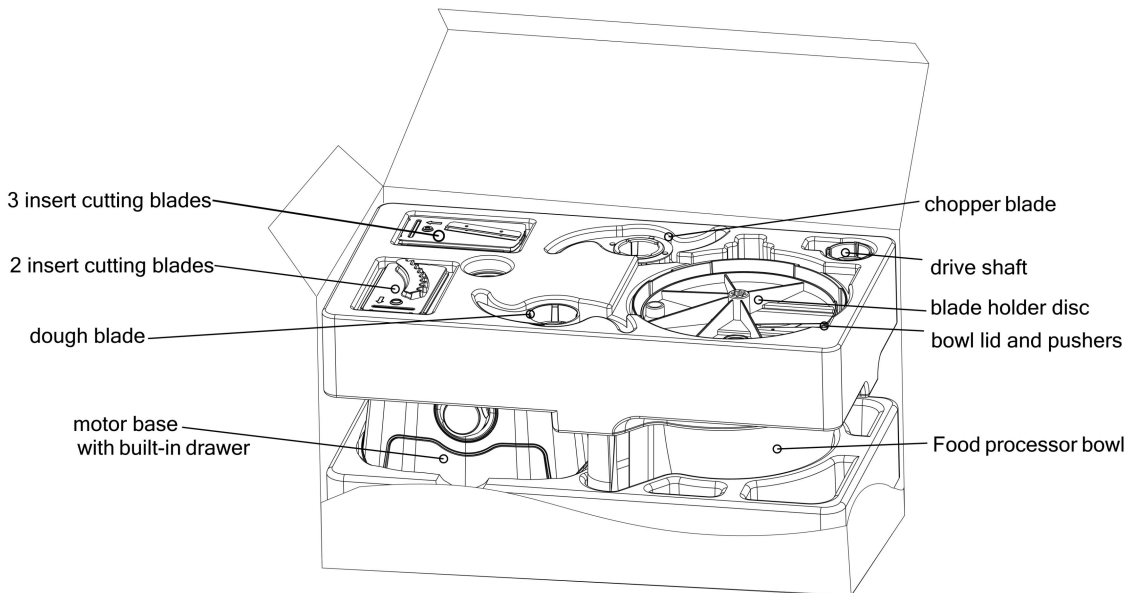

Thanks for purchasing Magiccos food processor. Please find all the packing contents and where are the packing positions inside the packing box.

Spatula, quick start guide page, manual & recipe book are packed in a bag on the top of the foam, please take out and read quick start guide and manual before operation.

### Notice:

- There is a round label on the bowl handle, please read the contents before using, please remove the label before cleaning in a dishwasher.
- Please read the contents of warning sticker on the motor base, keep the warning sticker and rating label on the motor base for further use and warranty.
- Please read the contents of the warning sticker on the bowl lid and save it.
- Please note that we used to put the blades in the drawer, but many customers returned the machine without checking the drawer carefully, so we had to change the packaging and put all the blades on the foam, please remove the sticker from the drawer and put all the blades in the drawer manually.
- Chopper blade with protectors and slicing blades with protective films, please remove them carefully before using, chopper blade protectors can be used for single time and if you need please save them for repeated use, no replacement can be provided for the films and protectors.

## Important Safety Cautions

Your safety and the safety of others are very important.

Important safety messages are provided in this manual and on your appliances.

Always read and obey all safety messages.



This is the safety alert symbol.

This symbol alerts you to potential hazards that can kill or hurt you and others. All safety messages will follow the safety alert symbol and either the word "DANGER" or "WARNING".

These mean:



You can be killed or seriously injured if you don't immediately follow instructions.



You can be killed or seriously injured if you don't follow instructions.

All safety messages will tell you what the potential hazard is, tell you how to reduce the chance of injury, and tell you what can happen if the instructions are not followed.

When using electrical appliances, basic safety precautions should always be followed, including the following:



### WARNING

When using electrical appliances, basic safety precaution must always be followed:

1. Carefully read all instructions before operating and save for future reference.
2. **FOR HOUSEHOLD USE ONLY. DO NOT USE THIS APPLIANCE FOR OTHER THAN ITS INTENDED USE.**
3. REMOVE all packaging materials before first use.
4. Wash food contact parts before first use.
5. This appliance is not intended for use by persons (including children) with reduced physical, sensory or mental capabilities, or lack of experience and knowledge, unless they have been given supervision or instruction concerning use of the appliance by a person responsible for their safety.

6. **DO NOT** allow young children to operate or use it as a toy. **CLOSE SUPERVISION IS NECESSARY WHEN USING THIS APPLIANCE NEAR CHILDREN.**
7. Ensure the polarized plug fit into the polarized outlet only one way. If not, reverse the plug or contact a qualified electrician to install the proper outlet.
8. This appliance should always be used on a stable, dry, heat-resistant surface.
9. **DO NOT** modify the plug in any way.
10. If the supply cord is damaged, in order to avoid a hazard, it must be replaced by the manufacturer, service agent or similarly qualified persons before further use.
11. This appliance includes a safety system which prevents operation unless the accessories are securely installed.
12. If operation is not finished within 5 minutes, turn off the appliance and let it cool for 1 minute before the next round of operation. If more than 3 rounds of operation are required, cool down the appliance for 15-60 minutes to room temperature . This can lengthen lifespan of the appliance.
13. To protect against risk of electric shock, fire or personal injury, **DO NOT** immerse power cord, plug or motor base in water or any form of liquid, neither rinse it under tap water.
14. **DO NOT** process hot ingredients.
15. **DO NOT** push food with fingers, or other objects (like knives), always use the enclosed pusher for feeding food.
16. **Blades are very sharp**, be extremely careful when handling chopper blade and insert cutting blades, especially while assembling, disassembling and cleaning after use.
17. **DO NOT** let power cord hang over the edge of a table or counter, or touch any hot surface.
18. **DO NOT** place the appliance near a gas outlet, electric burner, or heated oven.
19. Ensure the capacities shown in the specifications section are not exceeded.
20. Always use a reliable earthed power supply to operate appliance.
21. Avoid contact with moving parts,keep finger away from working blades to prevent personal injury.
22. **DO NOT** add liquid exceed the max liquid level, and leakage may dirty or even burn the appliance.
23. **DO NOT** sharpen the blades.
24. **DO NOT** use the cracked bowl.

25. **DO NOT** add overmuch food into the appliance.
26. **DO NOT** use the appliance if the chopper blades are bent or damaged.
27. Never operate the appliance without the lid and bowl in place, always place the pusher to avoid food or liquid leakage
28. **DO NOT** try to defeat the interlock mechanism.
29. Make sure the chopper blade and cutting blades are properly assembled before operating the appliance.
30. Switch off and unplug
  - Before fitting or removing parts
  - When not in use
  - Before cleaning
31. Before removing the lid from the bowl
  - Switch off
  - Wait until the accessories/ blades have completely stopped
32. THERE ARE NO SERVICEABLE PARTS INSIDE THIS APPLIANCE.
33. The appliances are not intended to be operated by means of an external timer or separate remote-control system.
34. The food processor bowl is made of plastic with metal components. They should not be placed in a microwave oven.
35. Appliances contain valuable materials that can be recycled. Dispose of old appliances using appropriate collection systems in accordance with federal and local regulations.

**SAVE THESE INSTRUCTIONS**

## Technical Specification

Model: FP408

Voltage: 120V-60HZ

Rating power: 700W

Peak power: 1000W

Cord length: 35.4" (90.0cm)

Dimension: 11.0 " x 9.8" x18.1 " (28\* 25\*46 cm)

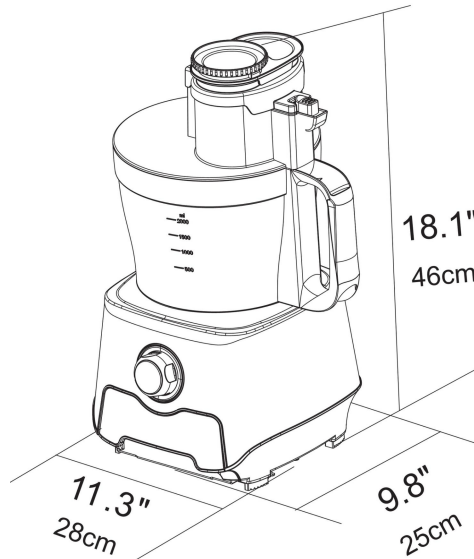

Food processor bowl max capacity: 3.5L / 14 Cups

Food processor bowl rating capacity: 2.0 L / 8 Cups

(2.0L rating level for shredding,slicing and French fry functions )

Processor bowl max liquid level: 1.0 L / 4 Cups

( 1.0L max liquid level for chopping and liquid processing with chopper blade )

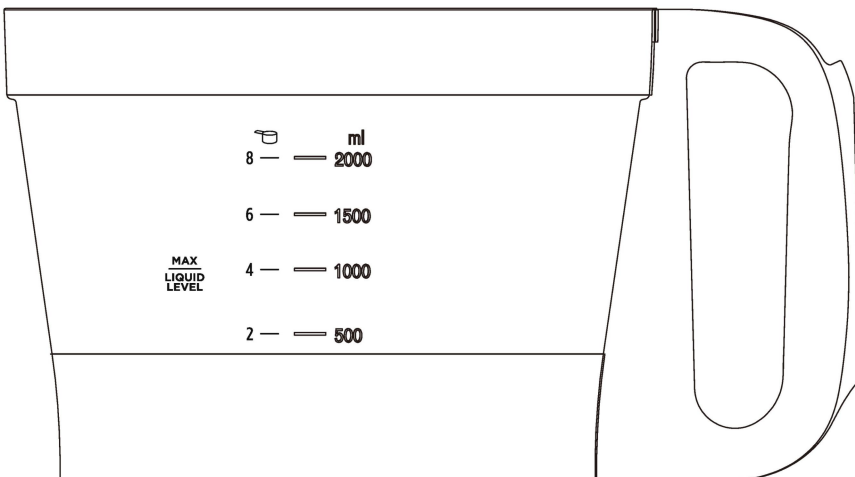



## Product Features

Magiccocos designed this new food processor for you, please notice below important features, it may help you to understand and use the food processor.

### Safety Lock System

NOTE: This appliance is equipped with a safety lock system, which can protect your safety while using the appliance, there are 3 safety locks in the **bowl , lid , protective cover and safety lock buckle**, the appliance cannot be turned on when any of the 3 locks are not well locked. Please refer to installation chapter to find how to lock them correctly. Please make sure the **bowl , lid , protective cover and safety lock buckle** are firmly locked to activate the safety locks.

**Notice:** If above parts are not locked in place, you **CAN NOT** turn on the appliance and bilking LED dictators only show you have a good input power connection, the safety system do not allow you to use the appliance to minimize the possible damage because of incorrect assembly. Before turning on the appliance, please make sure the the **bowl , lid, protective cover and safety lock buckle** are firmly locked in place.

### Overheating Protection

This appliance is equipped with a overheating protection thermostat (re-settable fuse) inside. If the motor temperature becomes too high, the unit will turn off automatically and resume operation after the motor has cooled down 30 minutes sufficiently (may need 15-60 minutes according to the room environment temperature), **unplug and reinsert again** could wake up the appliance.

Though equipped with a powerful and high speed motor, the overheating protection only can be triggered only by high load and long time working, it is a very extreme situation and very important for safety. For keeping a better motor working situation of the appliance and to avoid overheating protection situation, we suggest to use the appliance within 3 minutes continually per time, no more than 5 minutes continually per time, if overheating protection is already triggered, please cool down the appliance to room environment temperature (15-60 minutes), **unplug and reinsert**

again to wake up the appliance.

## Small, Medium & Big Feed Chute & Food Residues

The food processor have three kinds of feed chute. Small, medium and large feed chute available for different shapes of food.

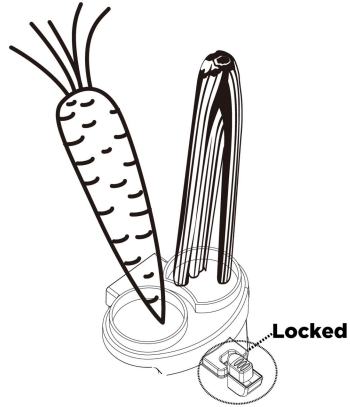
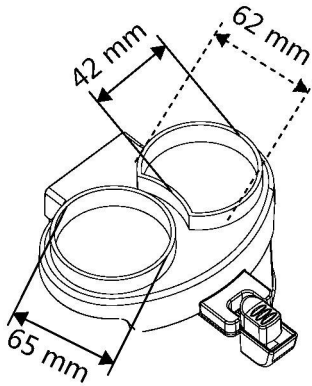

If the food is small or medium size, you can lock the protective cover and choose to use big pusher alone or small pusher & big pusher assembly together, please find below size of chute hole, you can place smaller food into the 1.6''\* 2.4'' (42mm\*62mm) hole or 2.5'' (65mm) dimension round hole. Kindly notice the 1.6''\* 2.4''(42mm\*62mm) hole is not a regular shape because of related safety requirements.

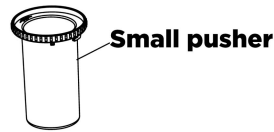

**Small pusher**

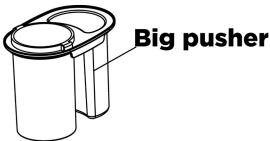

**Big pusher**

Or



**Small & big pusher are assembled together**

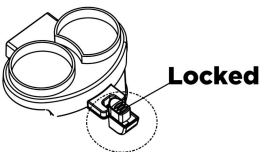

**Locked**

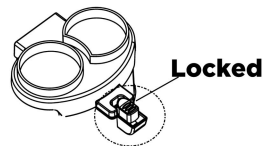

**Locked**

**Note:** Small pusher & big pusher could be assembled together for convenient use.

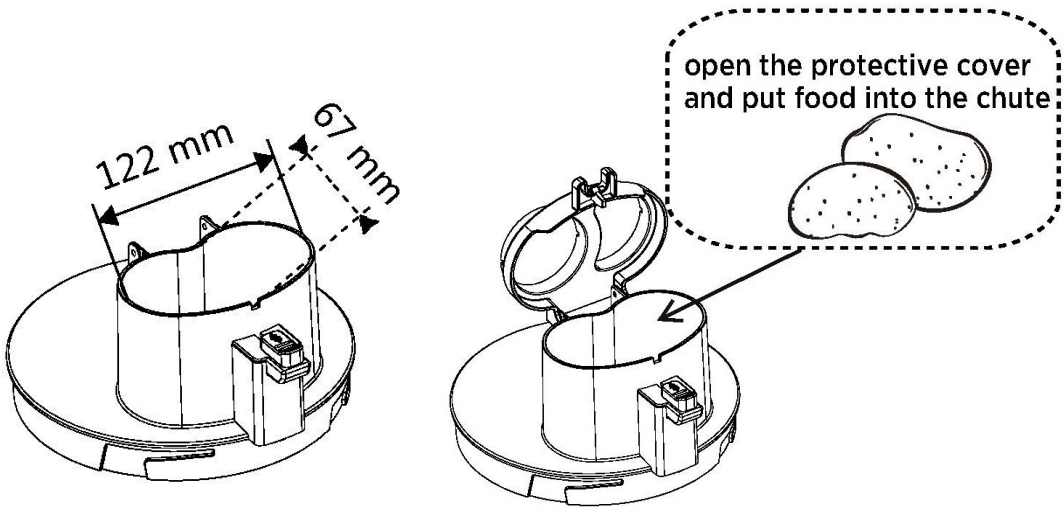

If the food is a larger size, such as big tomato or bigger size frozen cheese please cut them into suitable size, put it into the chute then lock the protective cover and lock the safety lock buckle, please use small pusher & big pusher assembly together to push food gently.

Kindly notice the chute hole is 2.6" \* 4.8" (67mm\*122mm) and is not a regular shape because of related safety requirements.

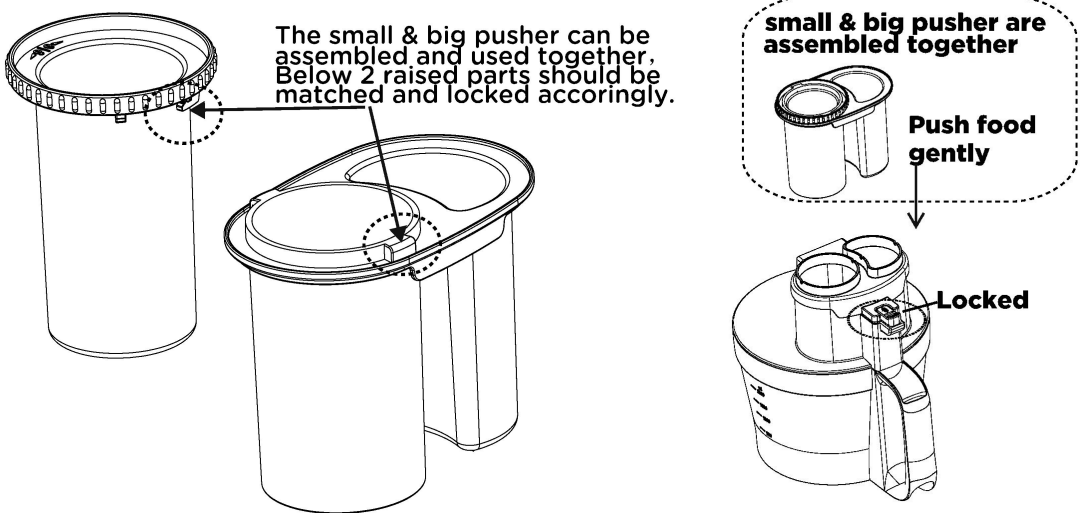

**Note:** please search Magiccoco's food processing demo video for your reference, any request for demo video please contact us via [support@magiccoco.co](mailto:support@magiccoco.co).

**About Food Residues:** Because of safety requirements, there is an enough safety distance between the cutting disc (blade holder disc) and bowl lid, this prevents moving and shaking cutting disc to contact the bowl lid.

The distance is also enough to protect your finger during operation, because of this safety reason then some food residues would be left on the disc, it is very normal.

To reduce food residues please select suitable size food chute, put the food as straight as it could be, If the food is tilted during the pushing it may lead to bad performance or more residues.

Please follow the instruction to **select suitable speed**, but because of personal operation differences, you can **adjust to a higher speed** or **bigger pressure** to avoid food residues.

### Blade Storage Drawer

The Magiccos FP408 food processor with a special designed storage drawer, please remove the seal sticker on the housing, you can dry and place all the blades in the drawer. 7 blades can be placed in 3 different holes as below figure.

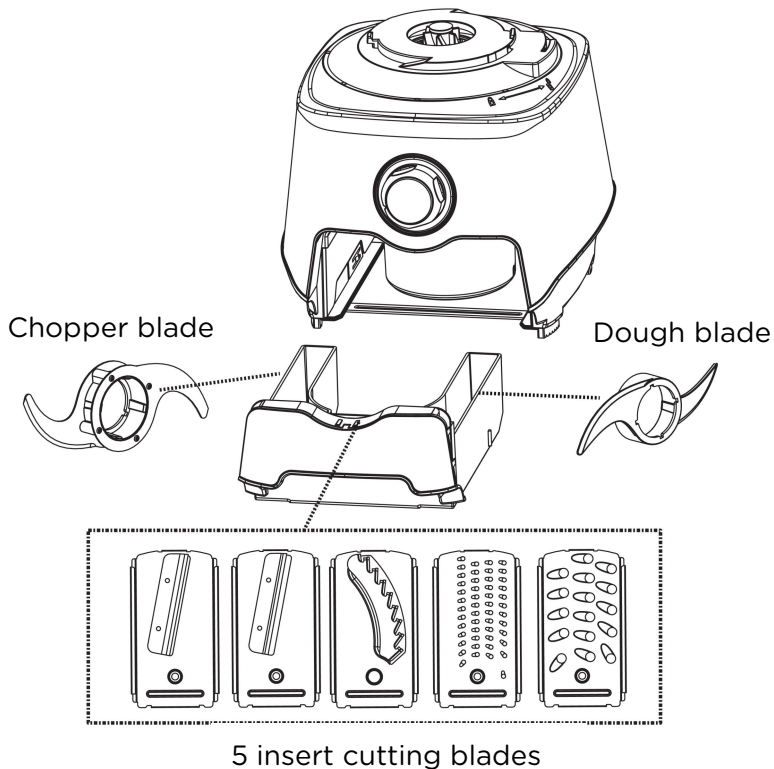

## Led Indicators & Working Condition

FP408 food processor with very nice blue and striking LED indicators, please find below table of working condition for your reference.

LED Indicators situation	Food Possessor Working Condition
All LED indicators are on and flashing.	Not working, flashing light warns you that the device has a good power connection but the bowl/bowl lid/protective cover/safety lock buckle are not locked in place.
Off gear indicator lights up	With the food processor in standby, you can rotate counterclockwise to select the PULSE function, or clockwise to select speeds from 1-7.
The LED Indicators below the related speed number are On	The food processor is in 1-7 speed operation and you can turn the knob to adjust the speed manually.
All LED Indicators are on and turn off quickly then OFF gear indicator is on	The food processor is in PULSE operation, release your finger and it goes back to OFF condition.

Please ensure proper installation so that the appliance will start up and be in good working condition.

Please do not operate the food processor if without reading the manual of quick start page.

Any abnormalities please stop using the appliance and check with Magiccos after sales support team.

## How To Select Speeds

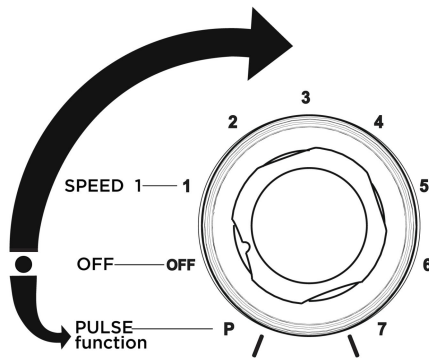

FP408 food processor has 7 speeds and a PULSE function. You can select different speeds according to the accessories and food, please find recommended speeds in the related chapters for each accessories. Turning clockwise to select from the 7 speeds and turning counter clockwise to select PULSE function.

**Speed 1 to 7** are from slow to fast. To select appropriate speed according to the food hardness and your processing needs. Normally, soft food can be processed by lower speeds. If the food fails to be processed or is stirred very slowly, it means that the speed is inappropriate. Then you need to replace it by higher speeds, below basic table for your reference.

Accessory	Food	Speed	Working Time
Chopper blade	Meat	PULSE 2-3 times, then turn to speed 7	Max 1 minute
Dough blade	Flour&water	Speed 1 and turn to speed 7 gradually	Max 1 minute
French Fry blade	Potato	Speed 7	Max 1 minute

### PULSE function

PULSE gear on the rotary switch for the max speed, release your finger to turn off the appliance, you **DO NOT** need to hold a long time, PULSE 2-3 times could let the ingredients to be roughly chopped and mixed, after that you could select related speeds accordingly.

**Note : some strength is required** for the best performance not matter which speed is used for pushing food through feed chute. If running speed is slow while food is very tough even working with speed 7, please **DO NOT** push too violently.

# How to Use the Appliance

## Installation

Please follow below reference installation steps, below part numbers have been listed on **page 1**.

1. Position the motor base② on the flat and dry place.
2. Position the food processor bowl ③ onto motor base②, place the bowl handle to

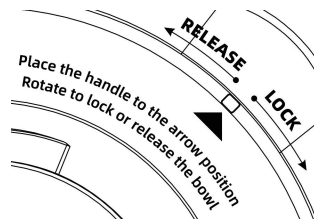

the arrow marking position on the base , turn clockwise to lock the bowl onto the base.

3. Take out the blade you want and follow below steps to put them into the bowl.
  - **When using the chopper blade⑬ or dough blade⑫**, just seat it onto drive shaft④, assemble the drive shaft④ and blade⑫⑬ together, then put them as an assembly together onto the food processor bowl③.

Assemble the chopper blade⑬ to the drive shaft④ according to the following steps (similar steps for assembling the dough blade⑫ and drive shaft④).

1. Find the **UP** side of the chopper blade

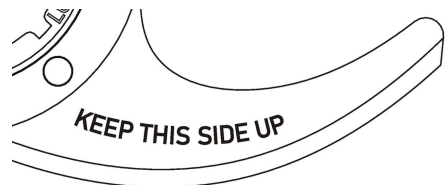

2. Find the 4 crossed notches near the 4 rivets

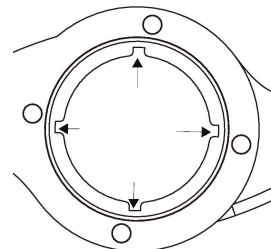

3. There are 2 big ribs on the drive shaft, let the drive shaft ribs completely go through 2 of the 4 crossed notches.

4. Push the chopper blade down to the end, holding the drive shaft and turn clockwise to lock the chopper blade & drive shaft as the **LOCK** direction markings shown on the chopper blade plastic part.

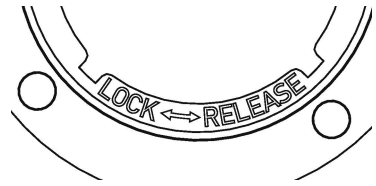

- **When using slicing, shredding or french fry cutting blades**, put the drive shaft ④ onto the food processor bowl ③, take out one blade from the blade drawer then insert it into blade holder disc ⑤, seat the blade (⑮⑯⑰⑱⑲) and blade holder disc ⑤ together onto the drive shaft ④, make sure the blade holder disc is firmly and evenly on the top of the drive shaft ④ before further operation.
4. Put food into the food processor bowl ③ then lock bowl lid ⑥, protective cover ⑧ and safety lock buckle ⑦ while using the chopper blade ⑬ or dough blade ⑫. When using slicing, shredding or French Fry blade ⑮⑯⑰⑱⑲, lock bowl lid ⑥, protective cover ⑧ and safety lock buckle ⑦ first, ingredients should be filled through feed chute once the appliance is running.

#### **Attention:**

- Only one of the 7 blades can be used each time.
- Always lock food processor bowl ③, bowl lid ⑥, protective cover ⑧ and safety lock buckle ⑦ before turning on the appliance.
- The rotary switch should be in the **OFF** position before plugging into the socket, check the LED situation and use PULSE function to confirm whether the appliance is well assembled. If there is anything abnormal, unplug the appliance and re-assemble the appliance as above steps.
- Please check how to install our appliance from Magiccoco's Amazon page.



## How to use chopper blade

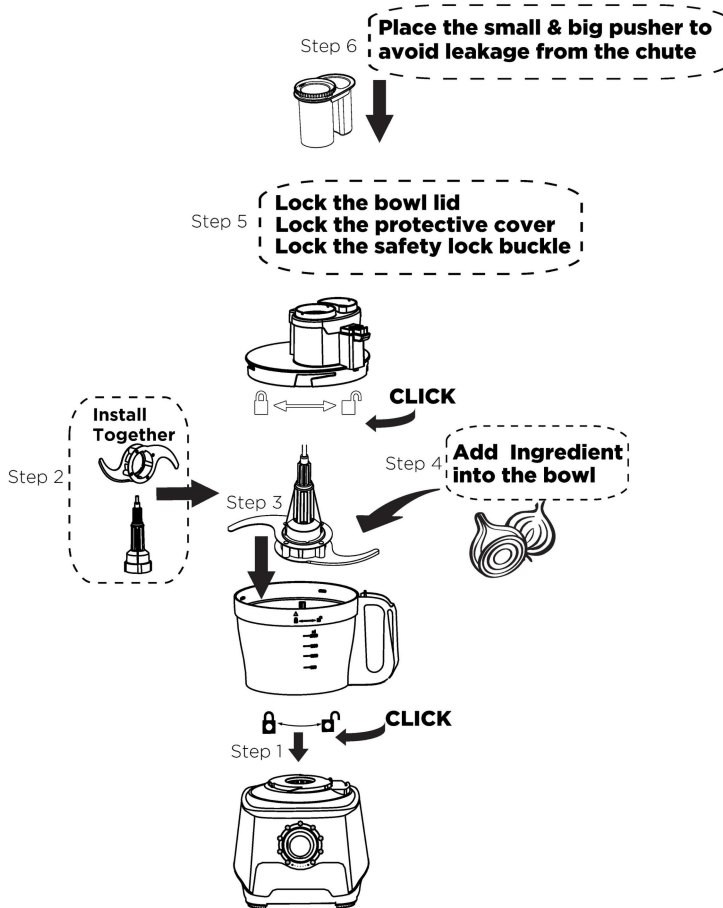

### Chopper blade ⑬& drive shaft④ assembly and usage

Place the motor base evenly on your countertop, with a good power outlet, follow above Fig and below steps to use the chopper blade assembly.

1. Place the food processor bowl handle position as the guiding symbols and words on base, lock the bowl firmly onto the base.
2. Find the **UP** side of the chopper blade (The laser markings on the blade show the upward side), find the 4 crossed notches on the chopper blade plastic part, there are 2 ribs on the drive shaft, let the ribs go through 2 of the 4 crossed notches , push the chopper blade to the end, holding the plastic part of the chopper blade

and twist the drive shaft clockwise as the **LOCK** directional marking to lock the chopper blade firmly.

3. Place the chopper blade & drive shaft assembly on the bowl center shaft.
4. Add ingredients into the bowl, if the food is big please cut them into smaller pieces and put evenly.
5. Lock the the bowl lid, lock the protective cover and safety lock buckle.
6. Place the small & big pusher together to avoid food leakage from the chute.

After finishing the above steps, please plug in and make sure it is in OFF gear with LED indicator showing standby condition, then you can turn on the appliance.

The volume per batch refer to the following table :

Ingredient	Volume	Speed	Working Time
Chocolate	≤200g	5-7 for mix	Max 1 minute
Soft Cheese	≤350g	5-7 for mix	Max 1 minute
Meat	≤800g	P / 7	30-60 seconds
Vegetable	250g	P / 7	30-60 seconds
Onion	≤800g	P / 7	30-60 seconds



#### **WARNING and TIPS**

- Please always follow above steps to install chopper blade and drive shaft together firmly or else you may can not chop food or even damage the bowl.
- Please cut food into smaller pieces for better performance, such as cutting meat into 2.5 cm pieces, PULSE 2- 3 times then turn to speed 7.
- Do not use chopper blade to cut bone or ice, the chopper blade is not designed for cutting such hard objects.
- The chopper blade is very sharp, please keep it away from children.
- Please be careful and always keep the blade protectors to avoid being cut.
- Clean and dry the chopper blade, you can keep it in the built-in storage drawer.
- If you always use the chopper function, after clean and dry you can keep the assembled drive shaft and chopper blade together in the bowl, but keep them away from children.

## How to use dough blade

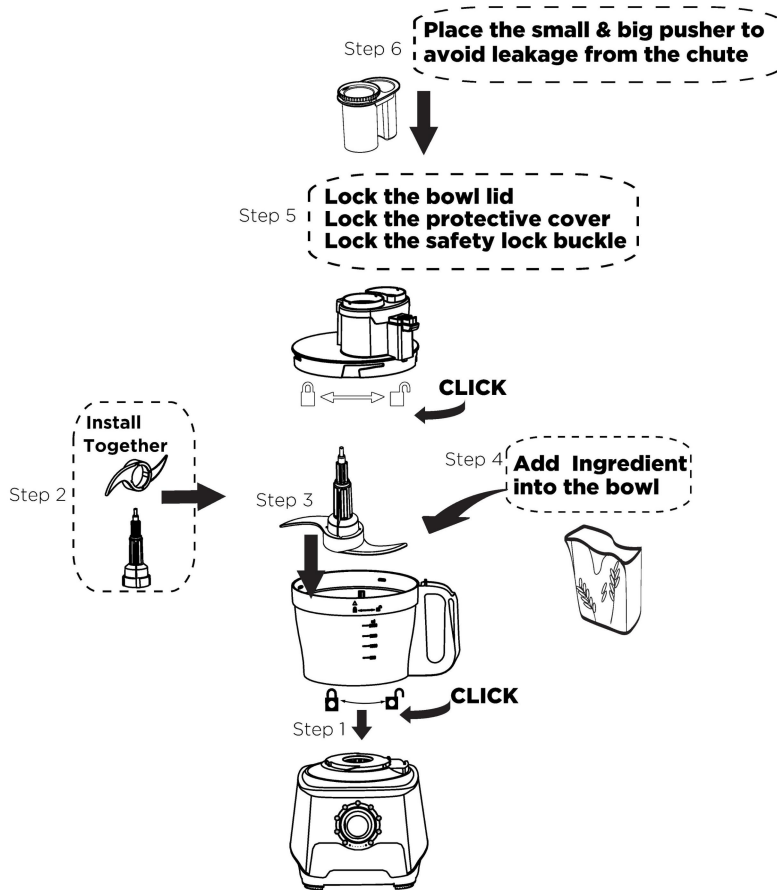

### Dough blade ⑫& drive shaft④ assembly and usage

Place the motor base evenly on your countertop, with a good power outlet, follow above Fig and below steps to use the dough blade assembly.

1. Place the food processor bowl handle position as the guiding symbols and words on base, lock the bowl firmly onto the base.
2. Find the **UP** side of the dough blade (please find the **UP** marking on the round cycle of the dough blade), find the 4 crossed notches on the blade plastic part, there are 2 big ribs on the drive shaft, let the ribs go through 2 of the 4 crossed notches of the dough blade, push to the end, holding the dough blade and twist the drive shaft clockwise to lock the dough blade firmly.
3. Place the dough blade assembly on the bowl center shaft.

4. Add ingredient into the bowl.
5. Lock the the bowl lid, lock the protective cover and safety lock buckle.
6. Place the small & big pusher together to avoid food leakage from the chute.

After finishing the above steps, please plug in and make sure it is in OFF gear with LED indicator showing standby condition, then you can turn on the appliance.

The volume per batch refer to the following table :

Ingredient	Volume	Speed	Working Time
Flour & Water	≤ 600g/360g	7	30-60 seconds
Egg	≤ 10 pcs	7	20-30 seconds
Flour & soft cheese	Totally ≤ 600g	7	30-60 seconds



### WARNING and TIPS

Add flour first then add water onto the flour, the ratio of flour to water for a nice dough is **1: 0.6**, which means 100g flour need 60g water (you can adjust ratio according to different types of flours).

The standard processing time is **30-60 seconds**, flour will become sticky if working time lasts too long, it will make the appliance shake more violently or work abnormally. If you can not have a nice dough within **60 seconds**, you may need to adjust the ratio by adding flour or water slowly, step by step, from the feed chute.

**About shaking** : food running inside unbalanced with a higher speed so the appliance could shake violently, almost all food processors have a similar situation. It will shake more obviously if it is more than **400g flour**, the 4 sucker feet could help to grasp the table, but if the shaking is too violently you can press down the appliance a bit till the dough is finished and try lesser flour next time.

# How to use 5 insert cutting blades

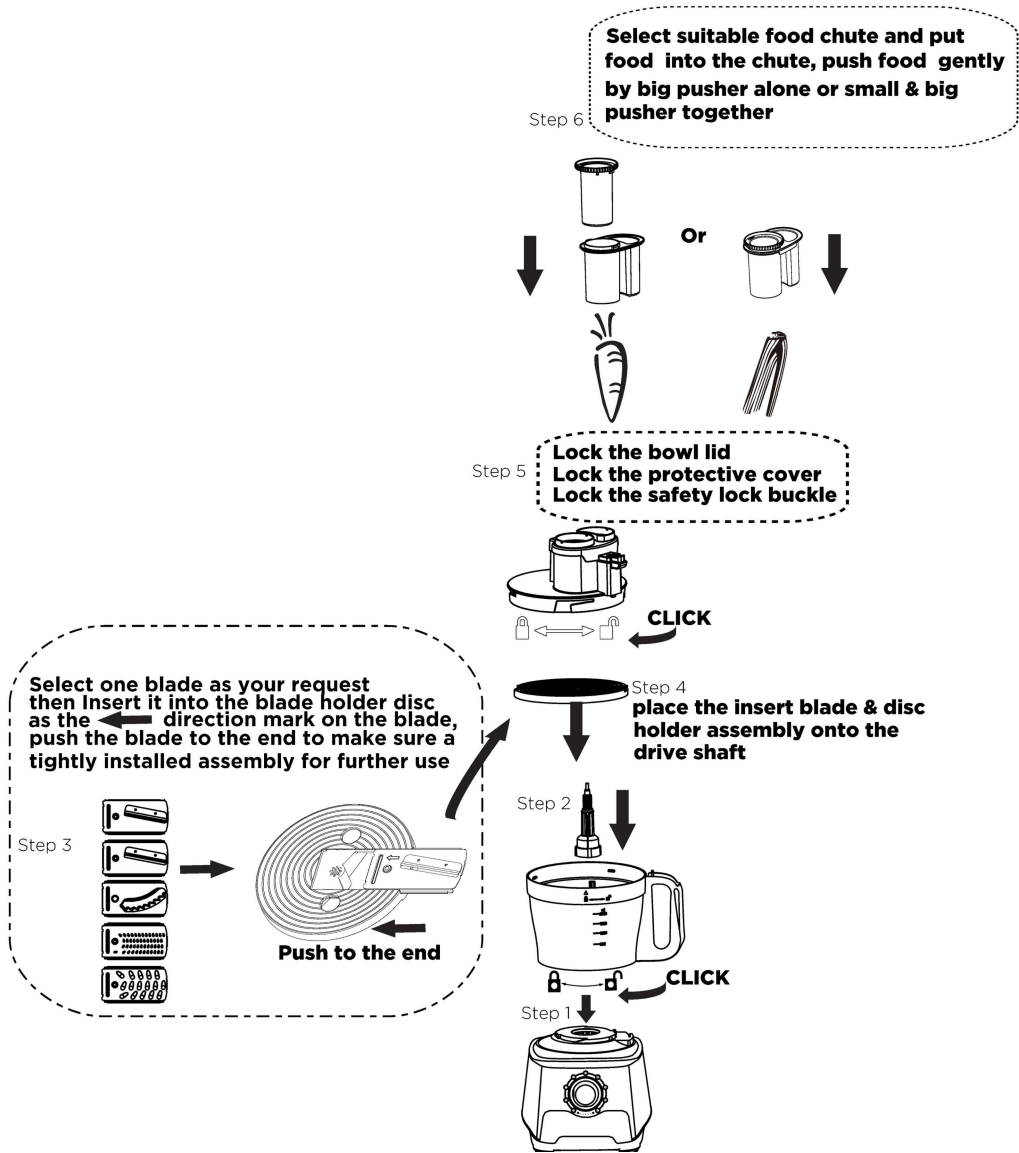

## 5 insert cutting blades ⑮⑯⑰⑱ and blade holder disc⑤assembly and usage



Place the motor base evenly on your countertop, with a good power outlet, follow above Fig and below steps to to use the insert cutting blade assembly.

1. Place the food processor bowl handle position as the guiding symbols and words on base, lock the bowl firmly onto the base.
2. Place the drive shaft on the bowl center shaft.



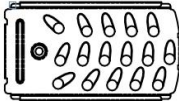
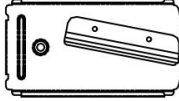
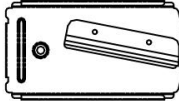
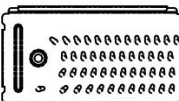

3. Select required cutting blade and insert the blade into the blade holder disc.
4. Seat the assembled blade holder disc onto the drive shaft, a bit pressure on the plastic part to make sure it seats firmly and evenly.
5. Lock the the bowl lid, protective cover and safety lock buckle.
6. Add food into suitable food chute, push gently by big pusher alone or small & big pusher assembly together.

After finishing the above steps, please plug in and make sure it is in OFF gear with LED indicator showing standby condition, then you can turn on the appliance.

The volume per batch refer to the following table :

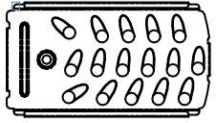
Ingredient	Accessory	Volume	Speed	Working Time
Potato		1 kg	5-7	Max 1 minute
Carrot		1 kg	5-7	Max 1 minute
Cucumber		1 kg	3-5	Max 1 minute
Firm cheese		200g	7	Max 1 minute
Frozen cheese		200g	7	Max 1 minute
Frozen butter		200g	7	Max 1 minute

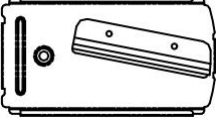
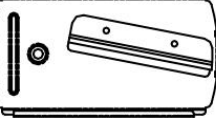
Select suitable cutting blades from the following table:

Blade name	Picture	Cutting results (food examples)
Coarse shredding insert blade		Approx 3mm(1/8'') thickness coarse stripes (carrot)
Fine shredding insert blade		Approx 1 mm (3/64'') thickness thin stripes (carrot) / or small particles (frozen cheese)
Coarse slicing insert blade		Approx 3.5mm(9/64'') thickness sliced pieces (cucumber)
Fine slicing insert blade		Approx 2.5mm(3/32'') thickness sliced pieces (cucumber)
French Fry insert blade		Approx 5mm (13/64'') chips (potatoes)



### WARNING and TIPS



For grating frozen cheese or butter you can select fine shredding insert blade for convenient use, because they are very tough so the running speed is much slower. **DO NOT** be violent while pushing ingredients. If the food shape is too big , please open the protective cover⑧, put food in and lock the protective cover⑧, then use the big pusher⑨ & small pusher⑩ assembled together for operation.

It's better to chop large shape ingredient into smaller one to fit the feed chute size.

Lower speed is recommended while slicing soft ingredient to prevent it from pasty, but if speed is not enough please change to a higher speed.

**DO NOT** slice frozen meat, it may damage the appliance.

Blades are very sharp, **BE EXTREMELY CAREFUL** when handling blades, especially while assembling, disassembling and cleaning after use.

Spatula is for scraping and cleaning the food processor bowl after the appliance stop operating. **DO NOT** put the spatula into the feed chute to stir the food while the appliance is working, it is very dangerous.

Please install the insert blade according to the **arrow** direction on the blade.

To release the blade, you can apply a gentle pressure on the blade and push in the opposite direction (avoid to contact the cutting edges ), you can also insert the raised bottom part of the spatula into round hole of the blade and apply a gentle pressures in the opposite direction to release the blade.

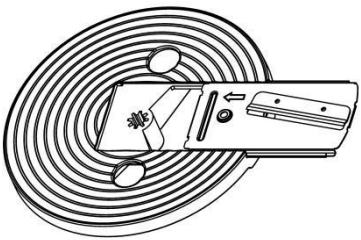
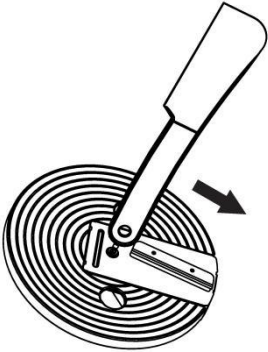
	
Install the insert blade according to the arrow direction on the blade	Release the insert blade and push in the opposite direction







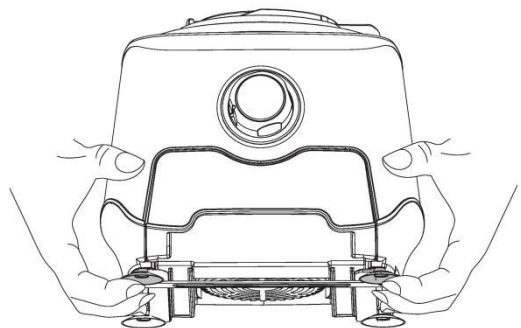
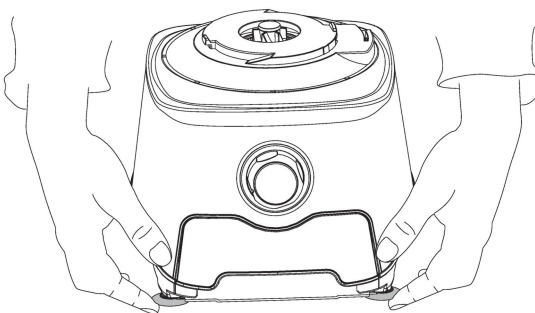





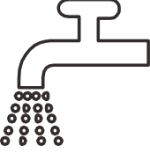
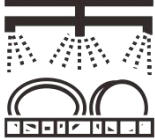

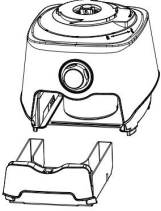



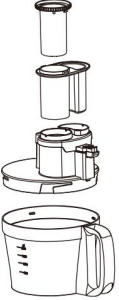

## Maintenance

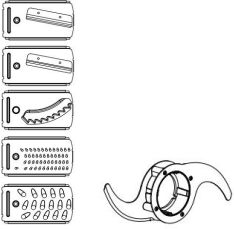
1. **DO NOT** immerse any cord, plug or motor base into water.
2. Please unplug the power cord to protect from electric shock while cleaning the appliance.
3. All removable accessories can be cleaned in water except motor base, dry the wet parts after cleaning, the detachable accessories are dishwasher-safe.
4. Always place the appliance in dry and flow place.
5. **DO NOT** use hard (solid) detergent to avoid scratch on product.
6. **DO NOT** operate the appliance for more than 5 minutes at a stretch for chopping and cutting functions and not more than 1 minute for blender function (Blender jar is an optional accessory, if you need one please contact Magiccos service), a stretch more than 5 minutes operation may trigger overheating protection of the motor. If operation is not finished within 5 minutes, turn off the appliance and let it cool for 1 minute before the next round of operation. If more than 3 rounds of operation are required, cool the appliance for 15-60 minutes to room temperature, to do so to avoid suddenly shutdown because of overheating.
7. Any other servicing should be performed by an authorized service representative, please contact Magiccos if any after service request.
8. lifting up the appliance by holding the motor base instead of holding bowl handle only, release the 4 suckers on the bottom before lifting up the base.

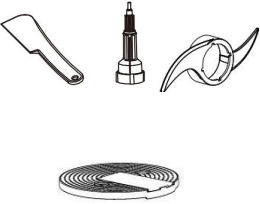

## Cleaning

Please find below parts and follow below instruction for cleaning, dish soap for better cleaning result, **DO NOT** use any corrosive chemical reagents and abrasive materials.

Parts			
			
			
			
			



## CAUTION

1. Make sure that the motor body is unplugged from power source before inserting or removing the blade assembly and before cleaning.
2. **DO NOT** immerse the motor body and adapters into liquids. Clean the device with a damp sponge or cloth.
3. The housing base may be wiped clean with a soapy, nonabrasive material. Be sure to dry it thoroughly.
4. Remove the adapters and attachments by twisting them.
5. **Hand Washing:** Wash the food processor bowl, chopper blade in warm soapy water. When washing the chopper blade, use a dish-washing utensil with a handle to avoid contacting with sharp edges. Rinse and air dry thoroughly.
6. **DO NOT** use any chemical reagents to wash or clean the application.
7. All parts except the housing base are dishwasher safe, and we recommend washing them in the dishwasher **on the top rack only**.
8. Due to intense water heat, washing the food processor bowl, cover and accessories on the bottom rack may cause damage over time. Insert the cover with the feed tube facing up to ensure proper cleaning. Insert the food processor bowl and pusher upside down. Remember to unload the dishwasher carefully wherever you have placed sharp blades.
9. To simplify cleaning, rinse the food processor bowl, cover, pushers and blades or discs immediately after use so food won't dry on them. Be sure to position the pushers upside down for drainage. If food lodges in the pusher, remove it by running water through it or any smaller cleaning brush.
10. If you wash the blades, discs by hand, please be carefully. When handling, use the plastic hubs. Avoid leaving them in soapy water where they may disappear from sight. To clean the blades, hold the blade by its plastic parts or blunt part.
11. If the feet leave spots on the counter, spray them with a spot remover and wipe

with a damp sponge.

12. If any trace of the spot remains, repeat the procedure and wipe the area with a damp sponge and nonabrasive cleaning powder.
13. After drying the blade or disc you can place the chopper blade & drive shaft assembly in the food processor bowl, keep the appliance or blades away from children and with power unplugged .
14. Wipe the exterior housing with a damp cloth and dry the stainless steel housing to avoid it to get rusted.
15. **DO NOT immerse any cord, plug or motor base into water.**

### **Dishwasher safety :**

All the parts except the motor base and drawer are dishwasher safety, but some parts are very small, we suggest you to clean small parts by running water, if you place the small parts in the dishwasher, please make sure **they could be firmly placed on the top rack** or else the plastic parts may contact high temperature heating tubes indirectly or directly by strong impact of the water flow and due to high temperature of the heating tubes the plastic parts may melt !



### **WARNING**

- The blades are sharp, be careful cleaning or holding the shredding blades or chopper blade.
- Contact with the edge of the blade may cause lacerations.
- Make sure all parts are thoroughly dry before reassembling or storing in the built-in drawer.
- Salt water can corrode and rust the stainless steel parts, please always clean and dry the stainless steel parts after using.

# Warranty

## Basic Warranty Information

Product Name	Food processor
Model Name	FP408
Default Warranty Period	1 Year Limited Warranty
For your own reference,we strongly recommend that you record your order number and date of purchase.	
Date of Purchase	
Order Number	

## Terms & Policy

The Magiccos products are premium in material, craftsmanship and service. They are effective from the date of purchase.

Magiccos will replace defective products based on eligibility. Refunds are available to the original purchasers of our products within the first 30 days of purchase. This warranty extends only to personal use instead of commercial, rental, or any other uses in which the product is not intended for. Each product has no other warranties other than the already provided warranties. This warranty is non-transferable. Magiccos is not responsible for any damages, losses or inconveniences caused by equipment's failure, user's negligence, user's abuse, or improper operation that does not follow the included user manual. If any special case please turn to last page and contact us for support.

This warranty does not apply to the following situations:

- Damage due to abuse, accident, alteration or vandalism.
- Improper or inadequate maintenance.
- Damage in return transit.
- Unsupervised use by children under 18 years old

Magiccocos and its subsidiaries are only responsible for damages caused by the intended use or as instructed in the user manual. Some states **DO NOT** allow this exclusion or limitation of incidental or consequential losses so the above disclaimer may not apply to you. This warranty gives you specific legal rights and you may also have other rights which may vary from state to state.

All expressed and implied warranties, including the warranty of merchant ability, are limited to the period of the limited warranty.







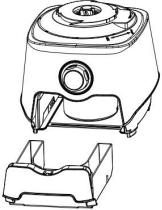

## **Defective Products & Returns**

Should your product prove defective within the specified warranty period, please contact the customer support via [support@magiccos.co](mailto:support@magiccos.co) with your order number and serial number, we will verify the problems and provide the best solution for you asap.

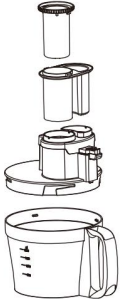
If you need to return the unit, please do not return the product to amazon directly, contact us we can provide quicker solution or replacement.

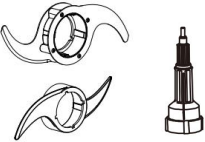
## Warranty and Accessories

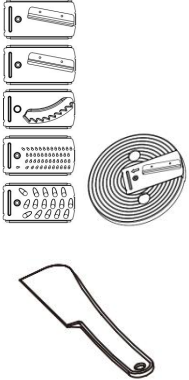
Please show the rate parts name or item numbers (refer to page 1) to after sales service team if you need accessory replacement.

Parts	Parts name	Covered or not	Remark
	<ul style="list-style-type: none"> <li>● Motor base</li> <li>● Drawer</li> </ul>		<p>One year Limited Warranty. Customer Damages Can not Covered by Free Warranty</p>
	<ul style="list-style-type: none"> <li>● Food processor bowl</li> <li>● Bowl lid</li> <li>● Big pusher</li> <li>● Small pusher</li> </ul>		<p>Fragile plastic parts. No free warranty. Special case please contact after sales support.</p>
	<ul style="list-style-type: none"> <li>● Chopper blade</li> <li>● Dough blade</li> <li>● Drive shaft</li> </ul>		<p>Wearable parts. No free warranty. Special case please contact after sales support.</p>
	<ul style="list-style-type: none"> <li>● 5 insert cutting blades</li> <li>● Blade holder disc</li> <li>● Spatula</li> </ul>		<p>Wearable parts. No free warranty. Special case please contact after sales support.</p>

Please send an email to [support@magiccos.co](mailto:support@magiccos.co) for after sales or warranty support.

Please provide below details for registration procedures :

Product Name	Food Processor
Model Name	FP408
If it is easier, you can send us your invoice or order number of your Amazon order and picture of rating label on the back of the motor base.	
Date of Purchase	
Order Number	
Serial number	
Email address or Tel-phone number	
Contact name	

## Delivery for Replacement

Once after sales support team confirmed the reasonableness and authenticity from your damaged part pictures or video, after sales support team can send the replacement to you from next working day without any additional shipping cost for delivery in USA (or Canada which matches the original Amazon order address) , the delivery time usually need 2-7 working days if there is enough stock, because of unstable oversea shipment if without stocks or need a longer delivery time we will inform you by email or phone and will try the best to provide quicker delivery.



## Troubleshooting

Please check manual and guide pages carefully, if you cannot find required answers please contact magiccos service or check demo video from magiccos Amazon page. Any problems please feel free to contact, some pictures or videos will help us to understand and solve your problems more quickly .

Problem	Solution
Appliance doesn't work	<p>Please make sure the food processor bowl, lid , protective cover and safety lock buckle are firmly locked to activate the safety lock system or else the appliance won't turn on ! Please check the installation demo videos on Magiccos official You tube channel or Amazon listing.</p> <p>Please check Led indicators &amp; working condition as per chapter, any abnormal LED indicator working condition please check with after sales support team.</p> <p>Make sure the bowl, lid, protective cover and safety lock buckle are <b>NOT BROKEN</b>, or else it is hard to activate the safety lock system and food processor can never work normally.</p> <p>Ensure correct assembly, please pay attention to the lock and unlock direction on the bowl / lid and motor base, please follow the arrows and markings to lock them firmly.</p> <p><b>NEVER</b> try to install the bowl with handle on the left, it cannot be installed! Please install the bowl with handle on the right as the guiding markings on the base.</p> <p>The bowl should be firmly locked to activate the safety locks, a new appliance could be a little tight to lock the bowl to the end, you may need a stronger push and make sure the handle with a 90-degree angle (<b>3 o'clock position</b>) facing to the right side, please try a clockwise click one more time if not locked in place.</p>

	<p>Make sure power plug is plugged in properly. Check if the mains have tripped, or if there is a power outage.</p>
<p>Appliance stops running suddenly</p>	<p>Food processor bowl or lid may loosen during vigorous processing, please re-install them.</p> <p>Please check whether any broken parts on the top or bottom of the bowl, bowl lid or protective cover, broken parts may cause inconsistent working conditions, please check with the after sales support team for replacement.</p> <p>There is an overheating protection function inside the appliance, long time operation will reduce the life of the food processor may trigger the overheating protection, we suggest you to use the appliance not more than 3 minutes continuous working per time, no more than 5 minutes per time to keep a longer lifetime of the appliance, over 5 minutes per time may trigger overheating protection, if already triggered the overheating protection, please cool down the appliance around 30 minutes (15-60 minutes according to the room temperate), <b>unplug and reinsert the plug</b> to wake up the appliance.</p>
<p>Motor is running while components DO NOT run</p>	<p>Make sure you have installed the drive shaft and blades correctly.</p> <p>Make sure the chopper blade is installed in a correct direction and you have push the blade to the end to make sure the blade is firmly installed.</p> <p>If the top of drive shaft is broken then blade holder disc will not run, please contact us to get a replacement.</p> <p>The bowl is broken and shaft can not run normally, please contact after sales support for replacement.</p>

Difficult to install the chopper blade and drive shaft

- Carefully Install the chopper blade over the drive shaft.
- Ensure that the UP marking (find the leaser markings on the blade ) is facing upward when fitting the blade onto the drive shaft.
- Find the 4 crossed notches
- Push the drive shaft ribs through 2 of the the plastic notches
- Rotate the drive shaft clockwise to lock the shaft and blade assembly firmly.
- Once aligned the chopper blade will lower down to the base of the drive shaft, the 2 ribs should completely above the 4 rivets on the chopper blade, place the chopper blade into the bowl it is almost touching the bottom of the food processor bowl.

If above steps are not so clear for you, please check our demo videos on Amazon page or contact us to provide demo video or support.



No



The chopper blade assembly is installed incorrectly  
The shaft with a long distance visible from the bottom part  
You can not chop food and it may damage the bowl !

The chopper blade assembly is installed correctly  
The shaft ribs are fully through the chopper blade  
The shaft ribs are above 4 rivets



<p>Appliance shakes violently</p>	<p>Put the appliance on a flat smooth place , the sucker feet can help to keep the balance of the appliance, make sure the rubber feet are clean and dry.</p> <p>Vibration is normal while working with some heavier loads (e.g., grating cheese/ making a dough),it may require the motor work harder, please hold the bowl a little bit if required.</p> <p>Make sure that the max load capacity is not being exceeded. Please put lesser food each time or else the appliance may loose balance, process in batches to avoid over loading.</p> <p>Please chop food into smaller pieces (such as cutting meat into 2.5 cm pieces) and put them evenly into the bowl to avoid shaking at start-up.</p> <p>Please install the chopper blade and drive shaft together as manual, the blades must be firmly installed. <b>Find the UP side and never install the chopper blade in the wrong direction, incorrect installation may result in abnormal vibration.</b></p> <p>Visible shake is normal while making a dough ( It will shake more obviously if it is more than <b>400g</b> flour ), please press down upon the lid till the a dough is finished, only need 30-60 seconds to finish a nice dough, do not let the appliance working too long each time. Process in batches to avoid over loading.</p>
-----------------------------------	--

<p>Chopping performance is not good enough</p>	<p>Please make sure the chopper blade is properly installed, please refer to chopper blade chapter or installation chapter on the manual.</p> <p><b>DO NOT</b> let the drive shaft working with 2 layers accessories, such as a chopper blade on the bottom and a slicing /grating blade on the top , it is <b>NOT ALLOWED !</b></p> <p>Please chop food into smaller pieces (such as cutting meat into 2.5 cm pieces) before putting them evenly into the bowl.</p> <p>Please do not chop ice or bone, it hurts the blade !</p>
<p>Slicing /grating performance is not good enough</p>	<p>It is normal for small pieces to remain for safety reason ; cut remaining bits by hand and add to processed ingredients.</p> <p>Put the food in a suitable size food chute hole, put the food as straight as it could be, If the food is tilted during the pushing it may lead to a bad cutting result or more residues.</p> <p><b>DO NOT</b> let the drive shaft working with 2 layers accessories, such as a chopper blade on the bottom and a slicing /grating blade on the top, it is <b>NOT ALLOWED !</b></p> <p>No matter which food you selected for slicing or grating please press evenly on the food, adjust to a higher speed or more pressure may result in better, but please do not push food violently.</p> <p>For grating frozen cheese, please always select speed 7 and putting more pressure on the cheese (but no need violently pressure while the grating speed is not fast).</p>

<p>Unpleasant smell</p>	<p>1. Many famous brands have a similar situation, please do not worry about the function and safety of the appliance. Only brand new appliances, the motor has some anti-rust paint. A burning smell is likely during the first 2-3 uses, after that there is no strong smell, don't worry, it is safe to use because there is a thermostat (re-settable fuse) inside the motor to protect you.</p> <p>2. Some heavier loads (such as grating frozen cheese) and longer working time which may let the motor have a higher temperate and may heat the anti-rust paint and give away burning smell and it is getting weaker and weaker after next 2-3 times, do not worry and it is safe to use because the motor have a thermostat (re-settable fuse) inside which can protect your safety.</p> <p>3. There is a brake mechanism on the motor. When you have an unsafe operation, such as suddenly opening the lid while the motor is rotating, the powerful brake action could cause a burning smell but it also ensure motor could stop instantly.</p>
<p>Liquid leakage problem</p>	<p>To ensure a smooth bowl &amp; lid operation and to avoid food clean problems for seal ring, the food processor do not have a seal ring on the lid which be used to avoid liquid leakage. Instead please do not add liquid more then the max liquid level, add more solid food or <b>turn to slower speed</b> to avoid liquid leakage problems. Please add to lesser level if it is milk or other liquids that tend to produce foam.</p> <p>Please always place the pushers to avoid liquid leakage.</p> <p>If already have leakage problems, please wipe the wet place and dry the appliance before next use, add lesser liquid and turn to slow speed next time for convenient use.</p> <p>If you process liquid food frequently and have higher performance requirements please contact us to buy an optional 1.8 L blender jug accessory which is specially designed for liquid processing (e.g. smoothies).</p>

<p>Rusting of metal parts</p>	<p>The food processor housing use SUS201 steel material with basic rust resistance, but it can not bare long time wet environment. So please clean and dry the food processor housing to avoid rust problem, if the housing is already get rusted, the rust spots can be wiped with wet cloth.</p> <p>The food processor food contact parts contain SUS304 / SUS303 / SU420 stainless steel material which can pass strict food contact testings, but even SUS304 / SUS303/SU420 stainless steel can have a rust problem because of wet, acidic and salty environments. This is the same to all the brands. So please clean and dry the blade and metal parts to avoid rust problems, once already have a rust problem please clean the part with a brush.</p>
<p>Missing parts or broken parts</p>	<p>Please find all the related parts which are packed as packing contents chapter on <b>page 2</b>.</p> <p>Please show the part number(refer to <b>page 1</b>) and send pictures or videos if do can not find some parts or find damaged parts, we can provide replacement accordingly to your feedback.</p> <p>Special case or new arrival units please contact our after sales team directly.</p>

## Recipes

Ensure you have read the instructions outlining assembly and operation before attempting to use the food processor. Below are some basic recipes to get started, these are guides and can be adjusted to taste.

### Fluffy Veggie Frittata (Serves 4)

#### Ingredients

- ½ onion
- 1 green bell pepper
- 1 Tbsp, olive oil
- 1 clove garlic, minced
- 1 handful spinach
- 6 eggs
- ½ cup milk
- salt & pepper, to taste
- ½ cup shredded cheese
- 1 tomato, thinly sliced

#### Method

1. To avoid cross contamination, wash hands after touching raw eggs.
2. Use the food processor to shred the onion and bell pepper.
3. Heat the oil in a a skillet over medium-high heat. Saute the onion and green pepper for 2-3 minutes. Add the garlic and spinach to the skillet and stir until the spinach starts to wilt. Reduce heat to medium-low.
4. Put the chopping blade in the food processor bowl and add the eggs and milk. Run on speed 1 until foamy (about 20-30 seconds).
5. Pour the egg mixture evenly over the vegetables. Salt and pepper to taste. Let cook for about 2 minutes. Sprinkle on the cheese and gently place the sliced tomatoes on top.
6. Cover the skillet and cook until the eggs are set (they should start to pull away from the edges) and the cheese is melted, 15-25 minutes.

### Garlic Feta Dip (Serves 6)

#### Ingredients

- 8 oz. feta cheese crumbles
- ½ cup sour cream
- ½ cup mayonnaise
- 1 lemon, zested and squeezed
- 1-2 cloves garlic
- ½ tsp. dried dill
- ½ tsp. dried oregano
- ½ tsp. dried thyme
- ¼ tsp. salt
- ¼ tsp. ground pepper
- red pepper flakes, to taste
- olive oil



## Method

1. With the chopping blade in place, add the feta, sour cream, mayonnaise, lemon zest and juice, garlic, dill, oregano, thyme, salt and pepper to the bowl.
2. Lock the lid in place and PULSE until mostly smooth.
3. Refrigerate at least 1 hour, then stir in the red pepper flakes and drizzle with olive oil. Serve with toasted pita bread or fresh vegetables.

## Chipotle Chicken Stew (Serves 4-6)

### Ingredients

- 20 oz. diced tomatoes with chilies
- ½ large onion, cut up
- 3 chipotle chilies in adobo sauce
- 2 Tbsp, adobo sauce
- 4 cloves garlic
- 1 tsp. ground cumin
- 1 tsp. salt
- 1 large zucchini, chopped
- 15 oz. black beans, drained
- 2lbs. boneless, skinless chicken thighs shredded cheddar cheese, to taste

## Method

1. Wash hands with soap and water. DO NOT rinse raw poultry. To avoid cross contamination, wash hands, utensils, cutting boards, etc. after touching raw poultry.
2. With the chopping blade placed in the bowl, puree the first 8 ingredients. Pour this into the pot of your slow cooker.
3. Stir the zucchini and beans into the sauce. Push the chicken down into the sauce.
4. Cover and cook on HIGH for 3 hours or LOW for 6-7 hours (internal temperature of the chicken should be 165° F when done).
5. Shred the chicken with 2 forks, top with cheese and serve hot.

## Cabbage and Pea Salad (Serves 10)

### Ingredients

- ¼ cup olive oil
- ¼ cup apple cider vinegar
- 1 tsp. dill weed
- ½ tsp. salt
- 1 medium cabbage, cut into chunks
- 1 large sweet onion, cut into chunks
- 16 oz. frozen peas, thawed
- pepper, to taste

## Method

1. Whisk together the oil, vinegar, dill and salt. Set aside.
2. Use the food processor to shred the cabbage and onion.
3. In a large bowl, mix the cabbage, onion and peas.
4. Pour the oil mixture over the cabbage and toss. Add pepper, to taste.

## Cauliflower and Squash Soup

### Ingredients

- ½ head cauliflower, cut into florets
- 2 acorn squash, cut in half and seeded
- 2 yellow bell peppers, cut into chunks
- 1 onion, chopped
- 5 cloves garlic, whole
- 1 cup water
- 1 cup low-fat sour cream
- 2 Tbsp, butter
- ½ tsp. paprika
- 1 tsp. dried basil
- 1 ½ tsp. salt
- ½ tsp. pepper
- Parmesan cheese, to taste
- Ground nutmeg, to taste
- 14 oz. chicken broth

## Method

1. Put the cauliflower, squash, peppers, onions and garlic on an oven-safe pan and spray lightly with cooking oil.
2. Using a conventional oven, roast for 30 minutes at 450° F, until vegetables are tender and a little charred. The squash may take a few minutes more.
3. Squeeze the cooked garlic from the skins into a food processor bowl with the chopping blade in place. In batches, puree the roasted vegetables (scoop the squash out of its skin first) until smooth. Pour into a slow cooker pot.
4. Add all remaining ingredients to slow cooker pot except the Parmesan and nutmeg. Stir well and cook on HIGH 3-4 hours or LOW 6 hours.
5. Serve with grated Parmesan and a sprinkle of nutmeg.

## Pesto - Makes One Cup

### Ingredients

- 6 cups of basil
- ½ cup of pine nuts
- ½ cup of grated Parmesan
- 1-2 cloves of garlic
- ¼ teaspoon of salt
- ¼-½ cup of extra virgin olive oil

## Method

1. Using the chopper blade , blend half of the basil with all of the pine nuts, Parmesan and garlic until all items are chopped finely.
2. Stop the Food Processor, and scrape all contents off the sides to the bottom of the bowl.
3. Add the remaining basil and blend until the mixture has the consistency of a fine paste.
4. Continue to blend, and add olive oil in small amounts until you have your desired consistency.
5. Add salt to taste

## Hummus - Makes Two and a Half Cups

### Ingredients

- 4 cloves of garlic
- 2 cups of canned chick peas (drained)
- 1 ½ teaspoons of salt
- Tahini (⅓ - ½ cup)
- 6 tablespoons of lemon juice
- 2 tablespoons of water

## Method

1. Using the chopper blade , blend the garlic first until it is minced.
2. Add all remaining ingredients and blend until desired consistency is reached.

## Guacamole - Makes 1 ½ Cups

### Ingredients

- 2 ripe avocados, halved, stones
- 1 small red onion, peeled
- 1 ripe tomato, quartered
- 2 garlic cloves, peeled
- 1 small fresh red chilli, peeled
- 60mL ( ¼ cup) fresh lime juice
- Salt & ground black pepper, to taste

## Method

1. Using the chopper blade , add the tomato, onion, garlic and chili to the bowl. PULSE 2-3 times until the ingredients are roughly chopped then stop.
2. Add the avocado and turn to speed 1 for 5 seconds.
3. Add lime juice and seasoning to taste. Store in an airtight container and refrigerate.

## Beetroot Chickpeas (Hummus) Dip

### Ingredients

- 2 cups of cooked chickpeas (or 1 tin of chickpeas, drained)
- ¼ cup chickpeas brine (or ¼ of water)
- 1 roasted beetroot (or 5 slices of tinned beetroot)
- Juice of 1 ½ lemon
- ⅓ cup of tahini
- 1 teaspoon of cumin
- ¼ cup of olive oil
- 1 small garlic
- 1 teaspoon of salt

**NOTE:** If beetroot is hard to source in your area, you could use 2 roasted carrots instead. The sweetness coming from the carrot is as equally delicious, however, instead of adding ¼ cup of water, increases it to ⅓ of a cup (or more if needed) to thin out the consistency of the dip.

### Method

1. Using the chopper blade, mix all the ingredients in the food processor bowl and blend until smooth and creamy.
2. Store it in a container in the fridge until it is ready to be served.

## Zucchini Slice

### Ingredients

- 2 zucchini
- 1 large brown onion, quartered
- 3 rashers bacon, finely chopped
- 80g tasty cheese
- 1 cup self-raising flour
- ½ cup of oil
- 5 eggs, lightly beaten
- Salt & ground black pepper, to taste

### Method

1. Preheat oven to 170°C. Grease and line a non-stick rectangle ovenproof dish.
2. Using the chopper blade, add the onion and bacon to the bowl and PULSE until finely chopped.
3. Carefully remove the chopper blade and attach the shredding blade. Feed the zucchini and then cheese through the feed chute until finely grated.
4. Remove the disc adaptor and stir in the flour, oil and eggs using the spatula. Combine well then season with salt and pepper.
5. Pour into ovenproof dish and bake for 35-40 minutes until golden. Allow to cool before cutting.

## Creamy Coleslaw

### Ingredients

- ½ cup loosely packed parsley leaves
- ½ sweet onion
- 1 cup mayonnaise
- 1 tablespoon white vinegar
- 1 tablespoon sugar
- 1 large carrot, peeled
- 1 small cabbage head
- Salt & ground black pepper, to taste

### Method

1. Use the chopper blade to mince parsley and onion.
2. Add mayonnaise, vinegar, sugar, salt and pepper to bowl, and process for another 5 seconds to combine.
3. Carefully remove the chopper blade and attach the shredding disc.
4. Cut carrots in half crosswise, and feed through the shredding disc.
5. Carefully remove the shredding disc and attach the slicing disc.
6. Core cabbage and cut into manageable sizes, and feed through the slicing disc.
7. Add all ingredients to large bowl, and toss to mix. Keep in refrigerator for best flavour.

## Mayonnaise

### Ingredients

- 2 egg yolks
- ½ teaspoon salt
- 1 pinch freshly ground black pepper
- 1 teaspoon Dijon mustard or ½ teaspoon dry mustard
- 2 teaspoon white wine vinegar or lemon juice
- 1 cup light-flavoured olive oil or rice bran oil

### Method

1. Using the dough blade, add the egg yolks, seasonings, mustard and 1 teaspoon of the vinegar or lemon juice to food processor bowl and process until combined.
2. With the motor running, add 1 cup of oil gradually, ensuring that each addition has been absorbed before adding more. When all the oil has been incorporated, add the remaining vinegar or lemon juice.

## Potato Au Gratin

### Ingredients

- ¼ cup loosely packed parsley
- 125g Swiss cheese cut to fit in feed
- 1 kg of yellow potatoes, peeled and cut to fit in feed tube
- 1 ½ cups of cream
- Salt & ground black pepper, to taste

### Method

1. Preheat oven to 180°C and coat inside of a baking dish with cooking spray.
2. Using the chopper blade , process the parsley until finely chopped. Set aside when done.
3. Remove the chopper blade , and insert shredding disc.
4. Feed cheese through shredding disc then set aside.
5. Remove shredding disc, and insert the slicing disc.
6. Using moderate pressure, process the potatoes through the slicing disc. This should fill the bowl almost completely.
7. Arrange half of the sliced potatoes in the bottom of the baking dish, then sprinkle with half of the cheese, parsley and salt and pepper.
8. Add another layer of potato, then sprinkle the remaining cheese, parsley and salt and pepper, then carefully pour the cream over the entire dish. Cover with a sheet of sprayed aluminium foil, coated side down.
9. Place in oven and bake for 1 hour 15 minutes, then remove foil and bake for a further 10-15 minutes until brown.

## Minestrone Soup

### Ingredients

- 3 large carrots, roughly chopped
- 1 large onion, roughly chopped
- 4 celery sticks, roughly chopped
- 1 tablespoon olive oil
- 2 garlic cloves, crushed
- 2 large potatoes, cut into small dice
- 2 tablespoons tomato puree
- 2L vegetable stock
- 400g can chopped tomatoes
- 400g can butter or cannellini beans
- 140g spaghetti, snapped into short lengths
- ½ head savoy cabbage
- Crusty bread, to serve

## Method

1. With the chopper blade , add the carrots, onion and celery to the processor bowl and chop into small pieces. Heat the oil in a pan, add the processed vegetables, garlic and potatoes, then cook over a high heat for 5 minutes until softened.
2. Stir in the tomato puree, stock and tomatoes. Bring to the boil, then turn down the heat and simmer, covered, for 10 minutes.
3. With the shredding disc attached, shred the cabbage.
4. Tip in the beans and pasta, then cook for a further 10 minutes, adding the cabbage for the final 2 minutes. Season to taste and serve with crusty bread.

## Curry Paste

### Ingredients

- 125ml (½ cup) white vinegar
- 80ml (⅓ cup) vegetable oil
- 2 long fresh red chilies, deeded, roughly chopped
- 4 garlic cloves, peeled
- 1 thumb size piece of fresh ginger
- ¼ cup ground cumin
- ¼ cup ground coriander
- 1 tablespoon freshly ground black pepper
- 1 tablespoon garlic paste
- 1 tablespoon black mustard seeds
- 1 tablespoon ground turmeric
- 1 teaspoon ground cinnamon

## Method

1. Using the chopper blade , place all the ingredients into the bowl and process until a paste is formed. Use the spatula to scrape down the sides of the bowl.
2. Store in airtight container and refrigerate.

## Peanut Butter - Makes 1 ½ Cups

### Ingredients

- 2 cups roasted peanuts
- ½ teaspoon salt
- 1-2 tablespoons peanut oil or other oil
- Optional for sweeter peanut butter: 1-2 tablespoons honey or other sweetener

## Method

1. Using the chopper blade add peanuts to bowl. PULSE a few times until roughly

chopped. (For crunchy peanut butter remove ½ cup of the peanuts at this stage and set aside).

2. Run the processor for 1 minute. Remove the lid and use the spatula to scrape down the sides of the bowl. Repeat this 2 more times until the peanuts become a smooth glossy butter.
3. Add the salt and oil and any other sweeteners. Process for another 1-2 minutes until completely smooth. (Add reserved nuts for chunky peanut butter at this stage if desired).
4. Scrape out peanut butter using a spatula and use straight away or store in an airtight container and refrigerate.

## Strawberry and Rhubarb Granita

### Ingredients

- 1 cup thinly sliced fresh or frozen rhubarb
- 1 cup granulated sugar
- 2 tablespoons lemon or lime juice
- 8 cups fresh strawberries, hulled rhubarb
- 2 teaspoons lemon or lime zest
- ¼ teaspoon salt

### Method

1. Combine all of the rhubarb, salt and sugar in a medium saucepan with 1 cup of water, keep on medium-high heat, until rhubarb is soft.
2. After 8-9 minutes, remove from heat and pour the mixture through a strainer into a bowl, using a ladle to ensure rhubarb pulp is fully drained of liquid. Discard the pulp.
3. Using the chopper blade, process half of the strawberries with the lemon juice and zest and 1 cup of water until no chunks remain. Pour mixture into a medium-sized baking tray.
4. Pour strained rhubarb mixture into a food processor with the rest of the strawberries and process until smooth, and mix into the baking tray.
5. Put cling film over the tray, and freeze until solid. When serving, scrape with a spoon to create icy flakes.



## Coffee and Walnut Layer Cake

### For the Sponge

- ½ cup walnut pieces
- 8 ounces superfine sugar for greasing)
- 2 sticks soft unsalted butter (plus some for grating)
- 1 cups all-purpose flour
- 4 teaspoons instant espresso powder
- 2 ½ teaspoons baking powder
- ½ teaspoon baking soda
- 4 large eggs
- 1 - 2 tablespoons milk

### For the Buttercream Frosting

- 3 ¼ cups confectioners' sugar
- 1 ½ sticks soft unsalted butter
- Approx. 10 walnut halves (to decorate)
- 2 ½ teaspoons instant espresso powder (dissolved in 1 tablespoon boiling water)

### Method

1. Preheat the oven to 180°C/160°C Fan/gas mark 4/350°F.
2. Butter two 20cm / 8inch sandwich tins and line the base of each with baking parchment.
3. Using the processing disc, put the walnut pieces and sugar into the food processor bowl and blitz to a fine nutty powder.
4. Add the 225g/2 sticks butter, flour, 4 teaspoons espresso powder, baking powder, bicarb and eggs and process to a smooth batter.
5. Add the milk, pouring it down the funnel with the motor still running, or just pulsing, to loosen the cake mixture: it should be a soft, dropping consistency, so add more milk if you need to.
6. Divide the mixture between the 2 lined tins and bake in the oven for 25 minutes, or until the sponge has risen and feels springy to the touch.
7. Cool the cakes in their tins on a wire rack for about 10 minutes, before turning them out onto the rack and peeling off the baking parchment.
8. When the sponges are cool, you can make the buttercream.
9. PULSE the confectioners' sugar in the food processor until it is lump free, then add the butter and process to make a smooth icing.
10. Dissolve the instant espresso powder in 1 tablespoon boiling water and add it while still hot to the processor, pulsing to blend into the buttercream.
11. Then beat in the hot coffee liquid.
12. Place 1 sponge upside down on your cake stand or serving plate.
13. Spread with about half the icing; then place on it the second sponge, right side up (i.e. so the 2 flat sides of the sponges meet in the middle) and cover the top with the remaining icing in a ramshackle swirly pattern.

## Basic Shortcrust Pastry

### Ingredients

- 2 cups (300g) plain (all-purpose) flour
- 145g butter
- 2-3 tablespoons iced water

### Method

1. With the dough blade, process the flour and butter in the food processor bowl until the mixture resembles fine breadcrumbs. While the motor is running, add enough iced water to form a smooth dough.
2. Remove dough from the bowl. Knead very lightly then wrap the dough in plastic wrap and refrigerate for 30 minutes.
3. When ready to use, roll out on a lightly floured surface until 3mm thick.

## Dark Choc-Chip Cookies

### Ingredients

- 125g unsalted butter, chopped
- 100g (½ cup, firmly packed) brown sugar
- 70g (⅓ cup) caster sugar
- 1 teaspoon vanilla essence
- 225g (1 ½ cups) self-raising flour
- 190g (1 cup) dark cooking choc bits
- 1 egg

### Method

1. Preheat oven to 180°C. Line 3 baking trays with non-stick baking paper.
2. With the dough blade, place the butter, brown sugar, caster sugar, egg and vanilla in the food processor bowl and process until the mixture is creamy.
3. Transfer to a large bowl. Sift in the flour. Add the choc bits. Use a wooden spoon to mix until well combined.
4. Place dessert spoonfuls of the mixture, about 4cm apart, on the lined trays. Bake in oven for 12 minutes or until golden. Set aside on the trays for 5 minutes to cool before transferring to a wire rack to cool completely.

## Contact Us

- Your satisfaction is our goal! If you encounter any problems or have any questions about your new product, please feel free to contact our after-sales team at **support@magiccos.co** Monday-Friday, 9:00am-5:00pm PST.
- Any questions about product consultation, product installation or delivery, replacement, after-sales support, etc. Please contact: **support@magiccos.co**.
- Before contacting customer support, please have your order invoice and order number ready. Some pictures or videos will be more helpful for us to understand and solve your problem.
- If interested in sharing your demo video or developing a marketing partnership, please contact: **marketing@magiccos.co**.
- If you would like to follow our latest news or see if there are any new promotions and free trials of new models, please send an email to **promotion@magiccos.co**.
- If you have any suggestions or feedback on our products, please contact **feedback@magiccos.co**.
- For B2B cooperation, please **contact contact@magiccos.co**.

# Magiccos

Search Magiccos Official to follow our YouTube channel

Website: [www.magiccos.co](http://www.magiccos.co)

After Sales Support

Contact us : [support@magiccos.co](mailto:support@magiccos.co)